

K-Summit

Instructions

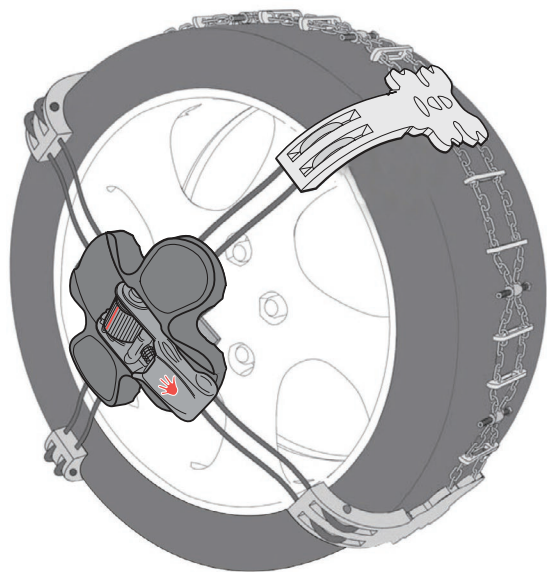

CONTENTS

K-SUMMIT

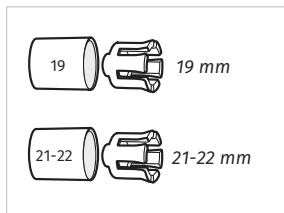

Optional
x2

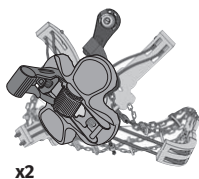

x2  35 mm

x2  70 mm



K-SUMMIT XL

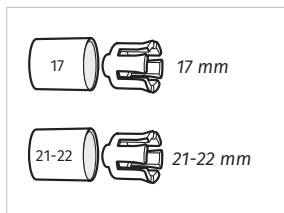

Optional
x2

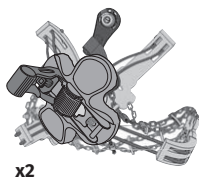

x2  35 mm

x2  70 mm



K-SUMMIT XXL

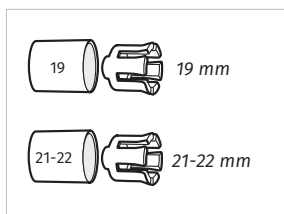

Optional
x2

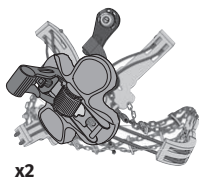

x2  55 mm

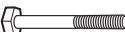
x2  70 mm



ADJUSTMENTS



EN After the purchase, and prior to using the snow chain, adjust it as shown in the following chapter.

IT Dopo l'acquisto, prima di utilizzare la catena, regolarla come indicato nel seguente capitolo.

DE Stellen Sie die Schneekette nach dem Kauf und vor der ersten Verwendung so ein, wie im nachfolgenden Kapitel gezeigt.

FR Après l'achat, avant d'utiliser la chaîne, la régler comme indiqué dans le chapitre suivant.

ES Después de la compra, antes de utilizar la cadena, regularla como se indica en la siguiente sección.

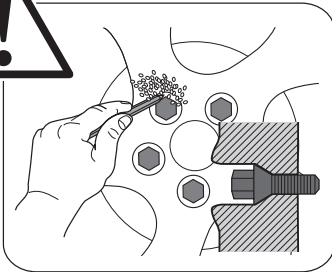

EN Certain vehicles may be equipped with nut caps. Before you install the snow chain, make sure you take them off, removing any snow or ice.

IT Alcuni veicoli possono essere equipaggiati con calotte copri dado. Prima di installare la catena verificare di averli rimossi, pulire da eventuale ghiaccio e neve.

DE Einige Fahrzeuge können mit Kappenmuttern versehen sein. Vor der Montage stellen Sie bitte sicher, dass Sie diese entfernt haben. Reinigen Sie sie von eventuellem Schnee oder Eis.

FR Certains véhicules peuvent être équipés avec des caches-écrou. Avant d'installer la chaîne, s'assurer qu'ils ont été retirés puis nettoyer l'éventuelle glace et neige.

ES Algunos vehículos pueden estar equipados con cubretuercas. Antes de instalar la cadena comprobar que se se han quitado y limpiar en caso de eventual hielo o nieve.

1. CHECK THE PRE-MOUNTED LUG NUT ADAPTER WITH THE VEHICLE'S WHEEL LUG NUT.

IT Verificare sul dado della ruota del veicolo, l'adattatore premontato sulla catena

DE Überprüfen Sie den auf die Kette vormontierten Adaptor auf der Radmutter.

FR Vérifier sur l'écrou de la roue du véhicule, l'adaptateur pré-monté sur la chaîne.

ES Verificar en la tuerca de la rueda del vehículo, el adaptador premontado en la cadena.

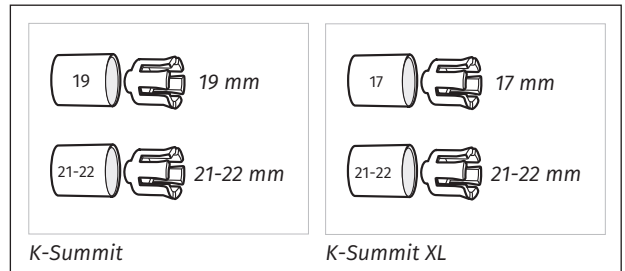
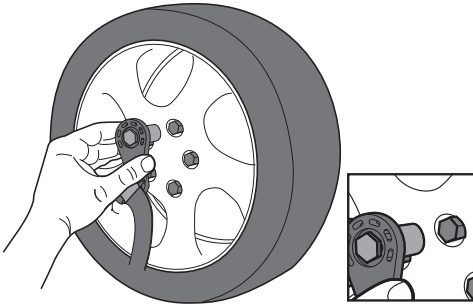

X.



EN If the pre-mounted lug nut adapter is not compatible with the vehicle (smaller or bigger than necessary), please use the other adapters included in the kit (X). Prior the installation, please verify that the hexagonal protrusion of the clamp A is correctly inserted into hex site of bell B (Y).

IT Nel caso in cui l'adattatore premontato non fosse corretto (diametro superiore/inferiore al necessario), provare gli altri adattatori presenti nel corredo (X). Prima dell'installazione, verificare il corretto inserimento della boccola esagonale della pinza A nel foro esagonale presente nella campana B (Y).

DE Sollte der vormontierte Adapter nicht passen (der Durchmesser ist größer/ kleiner als benötigt), überprüfen Sie, ob ein anderer Adapter aus dem Kit passt (X). Das richtige Einstecken der sechseckige Büchse von Klemme A in der sechseckigen Bohrung von Glocke B vor der Kettenmontage feststellen (Y).

FR Si l'adaptateur prémonté n'est pas le bon (diamètre supérieur/inferieur à celui nécessaire), essayer les autres adaptateurs inclus dans le kit (X). Avant l'installation, vérifiez que l'écrou 6 pans soudé sur la griffe A est correctement inséré dans la cloche B (Y).

ES En caso de que el adaptador premontado no fuera correcto (diámetro superior/inferior al necesario), pruebe los demás adaptadores presentes en el kit (X). Antes de la instalación, comprobar que el casquillo roscado hexagonal de la mordaza A se introduzca correctamente en el agujero hexagonal de la campana B (Y).

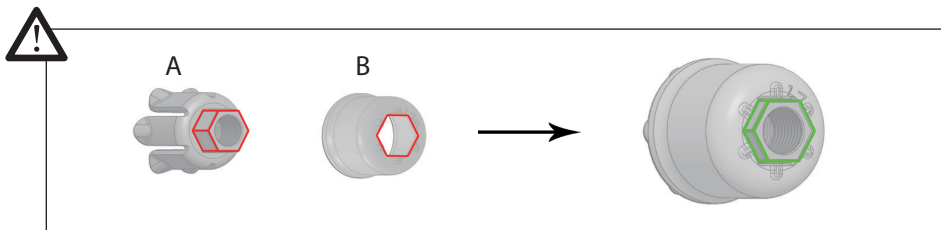

Y.

2. CHECK THE PRE-MOUNTED SPACER WITH THE VEHICLE'S WHEEL.

IT Verificare sulla ruota del veicolo, il distanziale premontato sulla catena.

DE Überprüfen Sie, dass der vormontierte Abstandhalter auf das Rad passt.

FR Vérifier, sur la roue du véhicule, l'entretoise pré montée sur la chaîne.

ES Compruebe el separador premontado en la cadena sobre la rueda del vehículo.

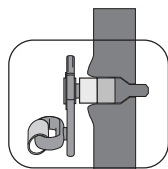
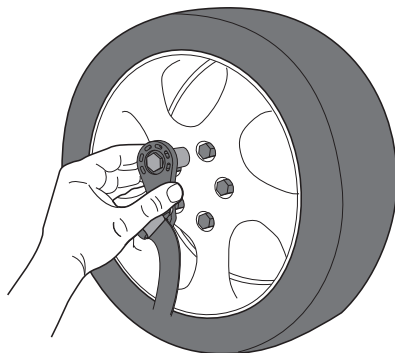

OK

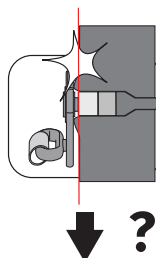

NO

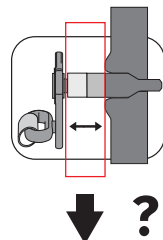

NO

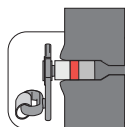
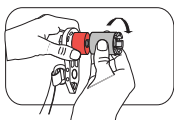
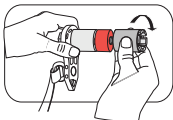
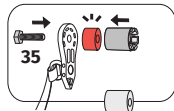
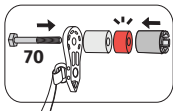
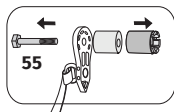
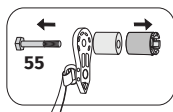
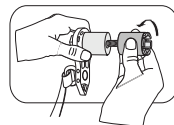
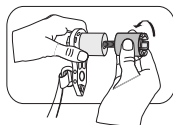

OK

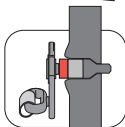

OK

3. SNOW CHAIN DIMENSION SETUP

IT Regolazione della dimensione della catena
DE Einstellen der Schneekettenabmessungen
FR Réglage de la dimension de la chaîne
ES Regulación de la dimensión de la cadena

EN Some tyre sizes require an adjustment of the chain dimension. Using the tools included in the kit (see picture below), remove on each chain, the number of regulation elements as indicated in the matrix at page 7

IT Alcune misure di pneumatico richiedono un adattamento della dimensione della catena. Togliere da ogni catena il numero di elementi di regolazione indicato nella tabella a pagina 7, utilizzare gli strumenti in dotazione (vd immagine qui sotto)

DE Einige Reifengrößen verlangen ein Einstellen der Schneekettenabmessungen. Entfernen Sie aus jeder Schneekette die Anzahl der Regulierungselemente, die in der Tabelle auf Seite 7 angegeben sind. Verwenden Sie das beigelegte Werkzeug (siehe nachfolgendes Bild)

FR Certaines mesures de pneu requièrent une adaptation de la dimension de la chaîne. Ôter de chaque chaîne le nombre d'éléments de réglage indiqué dans le tableau de la page 7 à l'aide des outils fournis (voir la photo ci-dessous)

ES Algunas medidas de neumático requieren una adaptación de la dimensión de la cadena. Retire de cada cadena el número de elementos de regulación indicado en la tabla de la página 7, utilice las herramientas suministradas (ver imagen inferior)

| Tyre Size | Adjustment |
|------------------|------------|
| 225/70-16 | OK |
| 265/50-18 | OK |
| 295/45-18 | OK |
| 265/45-19 | OK |
| 215/80-15 | -1 |
| 245/70-15 | -1 |
| 225/65-17 | -1 |
| 245/60-17 | -1 |
| 245/55-18 | -1 |
| 275/35-21 | -1 |
| 215/75-16 | -2 |
| 225/60-18 | -2 |
| 245/45-20 | -2 |
| 275/40-20 | -2 |
| 285/30-22 | -2 |

EN Hold on to the removed elements so that you can restore the original dimensions of the snow chain in case of need. Total: 4 elements.

IT Conservare gli elementi rimossi per poter ripristinare la dimensione originale della catena in caso di necessità. Totale: 4 elementi.

DE Bewahren Sie die entfernten Elemente auf, um notfalls die Originalabmessungen der Kette wieder herstellen zu können. Gesamt: 4 Elemente.

FR Conserver les éléments retirés afin de pouvoir rétablir la dimension originale de la chaîne si nécessaire. Total: 4 éléments.

ES Conservar los elementos que se han quitado para poder devolver la dimensión original de la cadena en caso de que sea necesario. Total: 4 elementos.

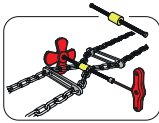

195/65-13
 185/55-15
 205/50-15
 225/45-15
 255/35-16

OK

185/70-13
 215/60-13
 225/40-16
 195/40-17

-1



195/60-14
 215/55-14
 175/60-15
 185/50-16
 205/45-16
 225/35-17
 225/30-18

-2



175/75-13
 235/45-15

-3



205/65-13
 185/65-14
 195/55-15
 215/50-15
 205/40-17

-4

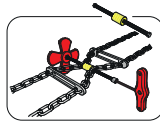

225/60-13
 175/70-14
 175/55-16
 195/50-16
 215/45-16

OK

195/70-13
 205/60-14
 225/55-14
 185/60-15
 245/45-15
 245/40-16
 215/40-17
 245/35-17

-1



205/55-15
 225/50-15
 195/45-17

-2



175/80-13
 185/75-13
 195/65-14
 175/65-15
 255/45-15
 285/40-15
 185/55-16

-3



225/45-16
 255/40-16
 255/35-17
 215/35-18
 255/30-18

-4



235/60-13
 215/60-14
 205/50-16
 225/40-17

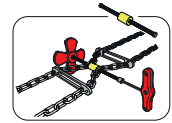

185/70-14
 195/60-15
 235/50-15
 175/60-16
 205/45-17
 225/35-18
 265/30-18

OK

205/70-13
 175/75-14
 215/55-15
 265/45-15
 235/45-16
 265/40-16
 235/40-17
 265/35-17
 225/30-19

-1



195/75-13
 205/65-14
 185/65-15
 195/55-16
 215/50-16
 205/40-18
 235/35-18

-2



225/60-14
 175/55-17
 215/45-17
 275/35-17

-3



185/80-13
 195/70-14
 175/70-15
 205/60-15
 225/55-15
 245/50-15
 275/45-15
 185/60-16
 245/45-16
 275/40-16
 245/35-18
 285/30-18

-4

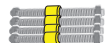

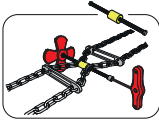

205/55-16
225/50-16
215/40-18
245/30-19

OK

185/75-14
195/65-15
225/45-17
295/30-18
215/35-19

-1



205/75-13
175/80-14
215/65-14
235/60-14
255/45-16
205/50-17
245/40-17
255/40-17
225/40-18
255/35-18
255/30-19

-2



185/70-15
215/60-15
235/55-15
195/60-16
225/35-19

-3



195/80-13
205/70-14
175/75-15
215/55-16
235/50-16
235/45-17
265/40-17
205/45-18
265/35-18
265/30-19
225/30-20

-4

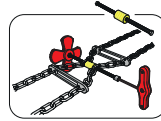

265/50-15
185/65-16
195/55-17
215/50-17
235/40-18
235/35-19

OK

195/75-14
245/60-14
205/65-15
275/35-18
275/30-19
235/30-20

-1



185/80-14
225/60-15
175/70-16
205/60-16
245/50-16
245/45-17
275/40-17
215/45-18
245/40-18

-2



195/70-15
275/50-15
225/55-16
185/60-17
245/35-19
285/30-19
245/30-20

-3



205/80-13
215/70-14
185/75-15
205/55-17
225/50-17
285/35-18

-4

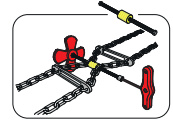

175/80-15
215/65-15
195/65-16
255/50-16
255/45-17
285/40-17
225/45-18
255/40-18
225/40-19
255/35-19
295/30-19
255/30-20

OK

205/75-14
235/60-15
215/60-16
235/55-16
295/35-18
225/35-20

-1



195/80-14
205/70-15
285/50-15
215/55-17
235/50-17
295/40-17
235/45-18
265/35-19
265/30-20

-2



225/70-14
175/75-16
265/50-16
265/45-17
265/40-18
235/40-19

-3



265/60-14
195/75-15
225/65-15
205/65-16
185/65-17
215/50-18
275/30-20

-4



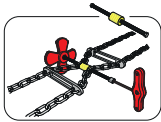

185/80-15
 245/60-15
 295/50-15
 225/60-16
 245/55-16
 205/60-17
 245/50-17
 245/45-18
 275/40-18
 275/35-19

OK

215/75-14
 195/70-16
 225/55-17
 275/45-17
 245/40-19
 245/35-20
 285/30-20

-1



205/80-14
 215/70-15
 275/55-15
 185/75-16
 205/55-18
 225/50-18
 285/35-19

-2



235/70-14
 255/60-15
 175/80-16
 215/65-16
 255/55-16
 255/50-17
 255/45-18
 285/40-18
 225/45-19
 255/40-19
 255/35-20
 295/30-20

-3



205/75-15
 235/60-16
 215/60-17
 295/35-19
 225/40-20

-4

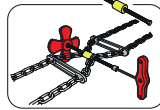

225/75-14
 195/80-15
 185/70-17
 235/55-17
 235/50-18

OK

225/70-15
 205/70-16
 205/65-17
 215/55-18
 265/45-18
 295/40-18
 235/45-19
 265/40-19
 265/35-20
 265/30-21

-1



195/75-16
 225/65-16
 235/40-20
 275/30-21

-2



215/80-14
 245/60-16
 295/50-16
 225/60-17
 245/55-17
 245/50-18
 275/35-20

-3



215/75-15
 225/55-18 no Continental
 275/45-18
 245/45-19
 275/40-19
 245/40-20
 245/35-21
 285/30-21

-4

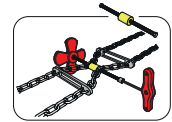
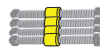

215/70-16
 275/50-17
 205/55-19
 285/35-20
 295/25-22

OK

205/80-15
 235/70-15
 275/60-15
 215/65-17
 225/55-18 Continental
 285/40-19

-1



205/75-16
 235/65-16
 255/60-16
 235/60-17
 255/55-17
 255/50-18
 285/45-18
 255/45-19
 255/40-20
 295/35-20
 255/35-21

-2



235/55-18
 235/50-19

-3



225/75-15
 195/80-16
 205/70-17
 295/40-19
 235/45-20
 265/40-20
 265/30-22

-4

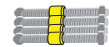

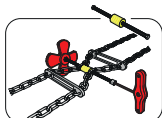

EN These instructions are for general information purposes and are not binding, as variations may occur. Carry out a fitting test before starting your journey to ensure that the chain, when properly adjusted, is correctly positioned on the tyre. With M+S tyres or in case the chain is not correctly positioned on the tyre after 300mt driving, it may be necessary to remove one more part than shown here.

IT Le informazioni qui contenute hanno validità generale e non vincolante in quanto potrebbero verificarsi delle variazioni. Effettuare una prova di montaggio prima di mettersi in viaggio per verificare che la catena opportunamente regolata si disponga correttamente sul pneumatico. Nel caso di pneumatici M+S o nel caso la catena non si sia disposta sul pneumatico in modo corretto dopo un percorso di 300mt, potrebbe essere necessario rimuovere un elemento in più rispetto a quanto qui indicato.

DE Die hier enthaltenen Informationen sind nur allgemein gültig und nicht verbindlich, da es zu Änderungen kommen kann. Bitte nehmen Sie eine Probemontage vor, bevor Sie Ihre erste Reise unternehmen, um sicher zu stellen, dass die angemessen eingestellte Kette sich ordnungsgemäß auf den Reifen legt. Wenn die Kette nach ca. 300 Metern Fahrstrecke noch nicht korrekt auf dem Reifen sitzt, kann ein weiteres hier gezeigtes Kettenglied entfernt werden. Dies kann auch bei M+S-Reifen der Fall sein.

FR Les informations fournies ici ont une validité générale et non contraignante dans la mesure où elles pourraient subir des variations. Effectuer un essai de montage avant de se mettre en route afin de vérifier que la chaîne réglée de manière adéquate se dispose correctement sur le pneu. Si des pneus M+S sont utilisés ou si la chaîne est mal positionnée sur le pneu, il peut être nécessaire d'ôter un élément de plus par rapport aux indications fournies ici, après que le véhicule a parcouru 300 mètres.

ES Las informaciones contenidas aqui tienen validez general y no son vinculantes, ya que podrían producirse variaciones. Efectúe una prueba de montaje antes de salir de viaje para comprobar que la cadena regulada en su momento se ajusta correctamente en su neumático. Con neumáticos M+S o en caso de que la cadena no esté correctamente colocada en el neumático podría ser necesario retirar un elemento más respecto a lo indicado después de haber recorrido 300 m.

225/70-16
265/50-18
295/45-18
265/45-19
195/55-20

OK

215/80-15
245/70-15
225/65-17
245/60-17
245/55-18
275/35-21

-1



215/75-16
225/60-18
245/45-20
275/40-20
285/30-22

-2



215/70-17
275/50-18
225/55-19
275/45-19
285/35-21

-3



235/75-15
205/80-16
235/70-16
275/55-17
295/30-22

-4

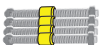

1. CHECK THE PRE-MOUNTED LUG NUT ADAPTER WITH THE VEHICLE'S WHEEL LUG NUT.

IT Verificare sul dado della ruota del veicolo, l'adattatore premontato sulla catena

DE Überprüfen Sie den auf die Kette vormontierten Adaptor auf der Radmutter.

FR Vérifier sur l'écrou de la roue du véhicule, l'adaptateur pré-monté sur la chaîne.

ES Verificar en la tuerca de la rueda del vehículo, el adaptador premontado en la cadena.

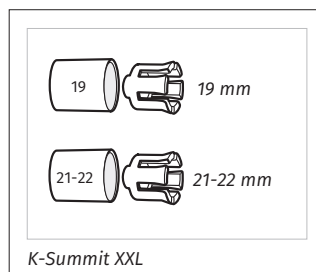
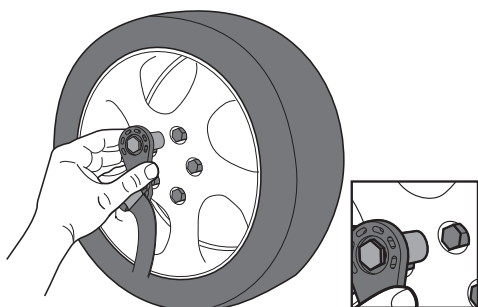

X.



EN If the pre-mounted lug nut adapter is not compatible with the vehicle (smaller or bigger than necessary), please use the other adapters included in the kit (X). Prior the installation, please verify that the hexagonal protrusion of the clamp A is correctly inserted into hex site of bell B (Y).

IT Nel caso in cui l'adattatore premontato non fosse corretto (diametro superiore/inferiore al necessario), provare gli altri adattatori presenti nel corredo (X). Prima dell'installazione, verificare il corretto inserimento della boccola esagonale della pinza A nel foro esagonale presente nella campana B (Y).

DE Sollte der vormontierte Adapter nicht passen (der Durchmesser ist größer/ kleiner als benötigt), überprüfen Sie, ob ein anderer Adapter aus dem Kit passt (X). Das richtige Einstecken der sechseckige Büchse von Klemme A in der sechseckigen Bohrung von Glocke B vor der Kettenmontage feststellen (Y).

FR Si l'adaptateur prémonté n'est pas le bon (diamètre supérieur/inferieur à celui nécessaire), essayer les autres adaptateurs inclus dans le kit (X). Avant l'installation, vérifiez que l'écrou 6 pans soudé sur la griffe A est correctement inséré dans la cloche B (Y).

ES En caso de que el adaptador premontado no fuera correcto (diámetro superior/inferior al necesario), pruebe los demás adaptadores presentes en el kit (X). Antes de la instalación, comprobar que el casquillo roscado hexagonal de la mordaza A se introduzca correctamente en el agujero hexagonal de la campana B (Y).

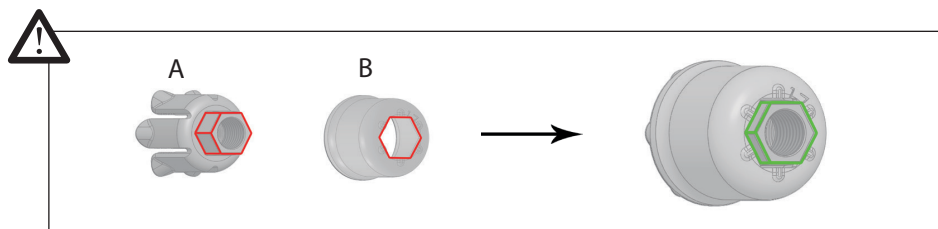

Y.

2. CHECK THE PRE-MOUNTED SPACER WITH THE VEHICLE'S WHEEL.

IT Verificare sulla ruota del veicolo, il distanziale premontato sulla catena.
DE Überprüfen Sie, dass der vormontierte Abstandhalter auf das Rad past.
FR Vérifier, sur la roue du véhicule, l'entretoise prémontée sur la chaîne.
ES Compruebe el separador premontado en la cadena sobre la rueda del vehículo.

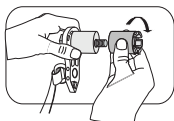
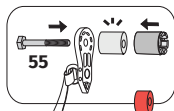
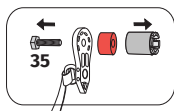
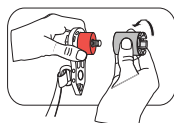
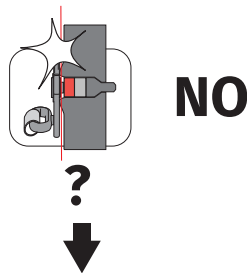
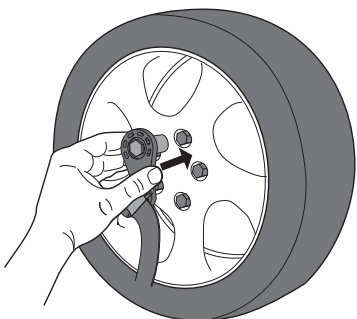

EN In case the problem is not solved, configure the fixing system as shown here below.
IT Nel caso in cui il problema non sia risolto, configurare il sistema di fissaggio come indicato qui sotto.
DE Sollte das Problem weiter bestehen, konfigurieren Sie das Befestigungssystem wie nachfolgend aufgezeigt.
FR Si le problème n'a pas été résolu, régler le système de fixation comme indiqué ci-dessous.
ES En caso de que no se resuelva el problema, configurar el sistema de fijación como se indica a continuación.

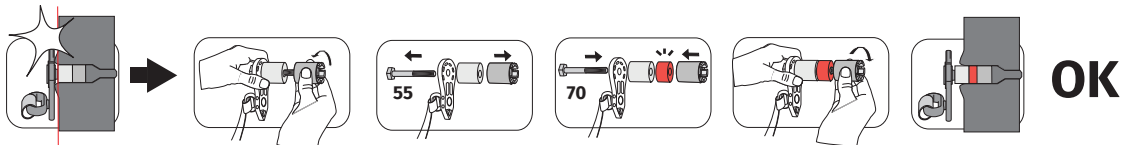

3. SNOW CHAIN DIMENSION SETUP

IT Regolazione della dimensione della catena
DE Einstellen der Schneekettenabmessungen
FR Réglage de la dimension de la chaîne
ES Regulación de la dimensión de la cadena

EN Some tyre sizes require an adjustment of the chain dimension. Using the tools included in the kit (see picture below), remove on each tyre, the number of regulation elements as indicated in the matrix at page 14

IT Alcune misure di pneumatico richiedono un adattamento della dimensione della catena. Togliere da ogni catena il numero di elementi di regolazione indicato nella tabella a pagina 14, utilizzare gli strumenti in dotazione (vd immagine qui sotto)

DE Einige Reifengrößen verlangen ein Einstellen der Schneekettenabmessungen. Entfernen Sie aus jeder Schneekette die Anzahl der Regulierungselemente, die in der Tabelle auf Seite 14 angegeben sind. Verwenden Sie das beigegefügte Werkzeug (siehe nachfolgendes Bild)

FR Certaines mesures de pneu requièrent une adaptation de la dimension de la chaîne. Ôter de chaque chaîne le nombre d'éléments de réglage indiqué dans le tableau de la page 14 à l'aide des outils fournis (voir la photo ci-dessous)

ES Algunas medidas de neumático requieren una adaptación de la dimensión de la cadena. Retire de cada cadena el número de elementos de regulación indicado en la tabla de la página 14, utilice las herramientas suministradas (ver imagen inferior)

| Tyre Size | Adjustment |
|--|------------|
| 225/70-16 265/50-18 295/45-18 265/45-19 | OK |
| 215/80-15 245/70-15 225/65-17 245/60-17 245/55-18 275/35-21 | -1 |
| 215/75-16 225/60-18 245/45-20 275/40-20 285/30-22 | -2 |

EN Hold on to the removed elements so that you can restore the original dimensions of the snow chain in case of need. Total: 5 elements.

IT Conservare gli elementi rimossi per poter ripristinare la dimensione originale della catena in caso di necessità. Totale: 5 elementi.

DE Bewahren Sie die entfernten Elemente auf, um notfalls die Originalabmessungen der Kette wieder herstellen zu können. Gesamt: 5 Elemente.

FR Conserver les éléments retirés afin de pouvoir rétablir la dimension originale de la chaîne si nécessaire. Total: 5 éléments.

ES Conservar los elementos que se han quitado para poder devolver la dimensión original de la cadena en caso de que sea necesario. Total: 5 elementos.

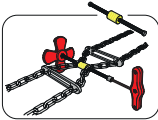
K66

225/75-15
195/80-16
205/70-17
235/50-19
295/40-19
235/45-20
265/40-20
265/30-22

OK

215/80-15
245/70-15
225/70-16
225/65-17
265/50-18
295/45-18
265/45-19
315/30-21

-1

215/75-16
245/60-17
245/55-18
225/60-18
225/55-19
245/50-19
275/45-19
245/45-20
275/40-20
315/35-20
245/40-21
275/35-21
325/30-21
285/30-22

-2

235/75-15
205/80-16
215/70-17
275/55-17
275/50-18
285/35-21

-3

255/70-15
235/70-16
255/65-16
275/60-16
235/65-17
255/60-17
235/60-18
255/55-18
255/50-19
285/45-19
255/45-20
285/40-20
255/40-21
295/35-21
295/30-22

-4

225/80-15
225/75-16
285/50-18
235/55-19
235/50-20
295/40-20
265/35-22

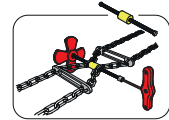
-5**K67**

245/75-15
225/70-17
265/55-18
265/50-19
295/45-19
265/45-20
305/35-21
265/40-21
315/30-22

OK

265/70-15
215/80-16
245/70-16
265/65-16
245/65-17
265/60-17
225/65-18
245/60-18
245/50-20
245/45-21
275/40-21
315/35-21
275/35-22

-1

275/50-19
275/45-20
305/40-20
285/35-22

-2

235/75-16
235/70-17
255/65-17
275/60-17
235/65-18
255/60-18
255/55-19
255/50-20
285/40-21

-3

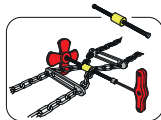
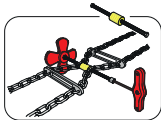

255/75-15
225/80-16
255/70-16
235/55-20
285/45-20

OK

225/75-17
285/55-18
265/45-21
295/40-21
265/40-22

-1



245/75-16
265/70-16
285/65-16
245/70-17
265/65-17
285/60-17
265/60-18
265/55-19
265/50-20
295/45-20

-2



235/80-16
275/45-21
275/40-22
315/35-22

-3



235/75-17
275/60-18
275/55-19
275/50-20
305/45-20
315/40-21
285/40-22

-4



225/85-16
255/75-16
275/70-16
255/70-17
275/65-17
255/65-18
235/65-19
255/60-19
235/60-20
255/55-20
255/50-21
285/45-21

-5



285/50-20
295/40-22
265/40-23

OK

245/75-17
285/60-18
265/45-22
305/35-23

-1



235/85-16
265/75-16
265/70-17
285/65-17
265/65-18
245/60-20
305/40-22

-2



275/55-20
275/50-21
275/45-22

-3



EN These instructions are for general information purposes and are not binding, as variations may occur. Carry out a fitting test before starting your journey to ensure that the chain, when properly adjusted, is correctly positioned on the tyre. With M+S tyres or in case the chain is not correctly positioned on the tyre after 300mt driving, it may be necessary to remove one more part than shown here.

IT Le informazioni qui contenute hanno validità generale e non vincolante in quanto potrebbero verificarsi delle variazioni. Effettuare una prova di montaggio prima di mettersi in viaggio per verificare che la catena opportunamente regolata si disponga correttamente sul pneumatico. Nel caso di pneumatici M+S o nel caso la catena non si sia disposta sul pneumatico in modo corretto dopo un percorso di 300mt, potrebbe essere necessario rimuovere un elemento in più rispetto a quanto qui indicato.

DE Die hier enthaltenen Informationen sind nur allgemein gültig und nicht verbindlich, da es zu Änderungen kommen kann. Bitte nehmen Sie eine Probemontage vor, bevor Sie Ihre erste Reise unternehmen, um sicher zu stellen, dass die angemessen eingestellte Kette sich ordnungsgemäß auf den Reifen legt. Wenn die Kette nach ca. 300 Metern Fahrstrecke noch nicht korrekt auf dem Reifen sitzt, kann ein weiteres hier gezeigtes Kettenglied entfernt werden. Dies kann auch bei M+S-Reifen der Fall sein.

FR Les informations fournies ici ont une validité générale et non contraignante dans la mesure où elles pourraient subir des variations. Effectuer un essai de montage avant de se mettre en route afin de vérifier que la chaîne réglée de manière adéquate se dispose correctement sur le pneu. Si des pneus M+S sont utilisés ou si la chaîne est mal positionnée sur le pneu, il peut être nécessaire d'ôter un élément de plus par rapport aux indications fournies ici, après que le véhicule a parcouru 300 mètres.

ES Las informaciones contenidas aqui tienen validez general y no son vinculantes, ya que podrían producirse variaciones. Efectúe una prueba de montaje antes de salir de viaje para comprobar que la cadena regulada en su momento se ajusta correctamente en su neumático. Con neumáticos M+S o en caso de que la cadena no esté correctamente colocada en el neumático podría ser necesario retirar un elemento más respecto a lo indicado después de haber recorrido 300 m.



1

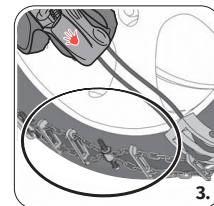
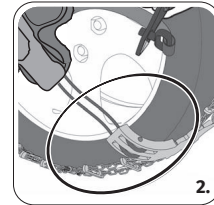
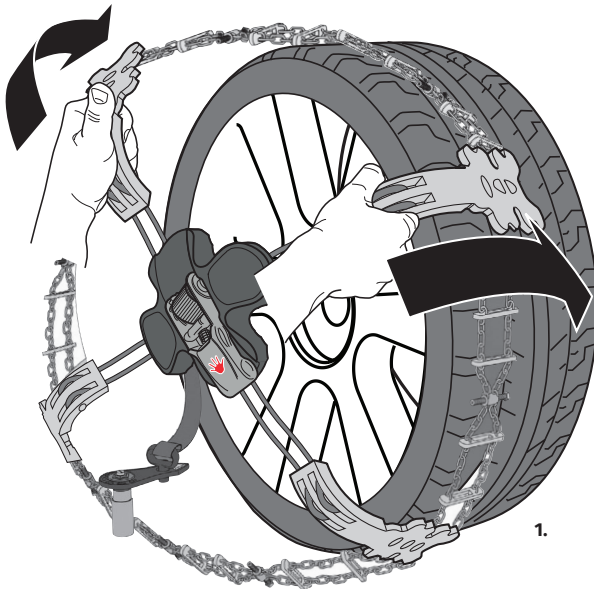

EN Open the arms of the chain, grab them at 10:10 as shown in the picture (1), position the two upper arms on the tyre, make sure the upper plastic plates adhere to the sidewall of the tyre, then join the lower arms of the snow chain as shown in the figure (2). (The bottom plates cannot be positioned on the tyre tread since the tyre is resting on the ground (3)).

IT Aprire le braccia della catena, impugnarle a ore 10:10 come indicato in figura (1), posizionare le due braccia superiori sullo pneumatico, far aderire le placche in plastica superiori alla spalla dello pneumatico, unire le braccia inferiori della catena come indicato in figura (2). (Le placche inferiori non potranno posizionarsi sul battistrada dello pneumatico in quanto il pneumatico poggia a terra (3)).

DE Öffnen Sie die Arme der Kette und halten Sie sie auf etwa 10.10 Uhr, wie in Abbildung (1) ersichtlich. Legen Sie die beiden oberen Arme auf den Reifen. Die oberen Plastikplaketten müssen auf der Reifenschulter aufliegen. Verbinden Sie die beiden unteren Arme der Kette wie in Abbildung (2) ersichtlich. (Die unteren Plaketten können nicht auf dem Reifenprofil aufliegen, da dieser die Erde berührt (3)).

FR Ouvrir les bras de la chaîne, les tenir à 10h10 comme indiqué sur la figure (1), positionner les deux bras supérieurs sur le pneumatique, faire adhérer les plaques en plastique supérieures au dos du pneumatique, unir les bras inférieurs de la chaîne comme indiqué sur la figure (2). (Les plaques inférieures ne pourront pas être positionnées sur la bande de roulement du pneumatique car le pneumatique touche le sol (3)).

ES Abrir los brazos de la cadena, colocarlos en posición de la hora 10 y 10 como se indica en la figura (1), posicionar los dos brazos superiores sobre el neumático, añadir las placas de plástico superiores al hombro del neumático, unir los brazos inferiores de la cadena como se indica en la figura (2). (Las placas inferiores no se podrán posicionar en la banda de rodaje del neumático ya que el neumático se apoya en el suelo (3)).

2

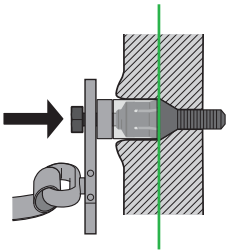
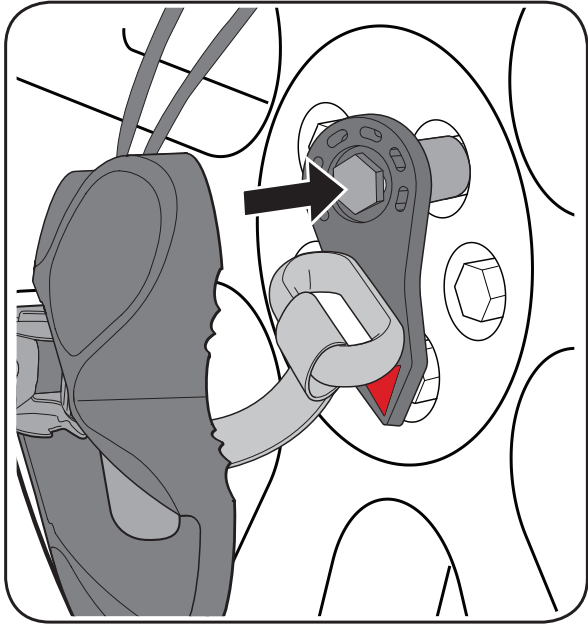

OK

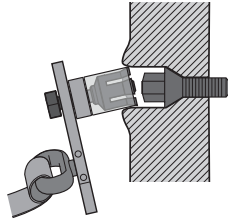

NO

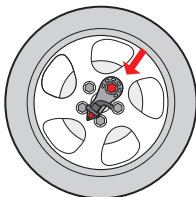

OK

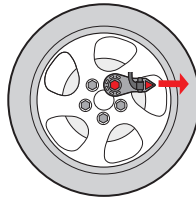

NO

3

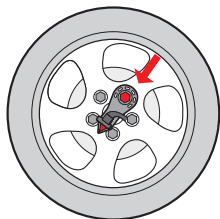
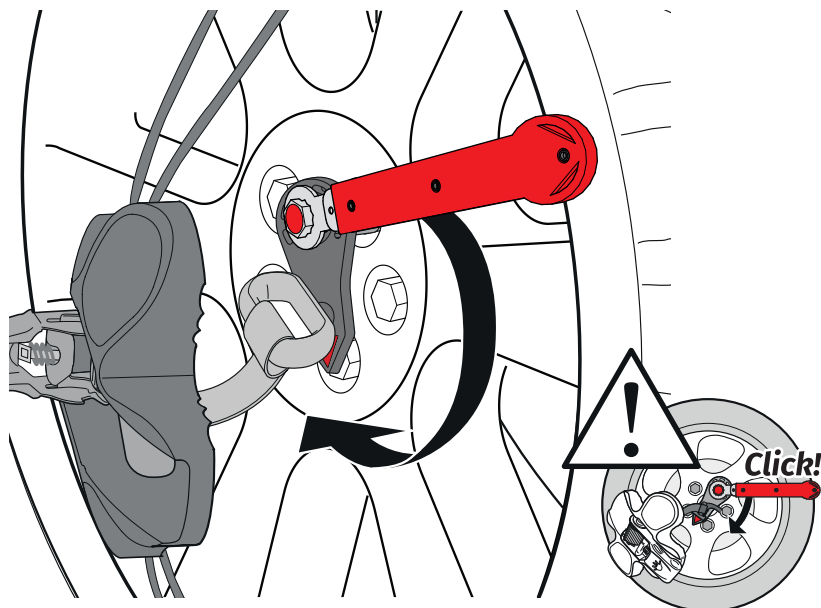

OK

EN Insert the tool on the screw hex head and torque until the tool clicks. Check that after screwing the red arrow is directed towards the center of the wheel.

IT Applicare la chiave sulla testa della vite e serrare la vite fino a sentire lo scatto della chiave. Verificare che alla fine del serraggio la freccia rossa sia direzionata verso il centro della ruota.

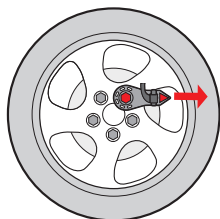

NO

DE Setzen Sie den Schlüssel auf den Kopf der Schraube und ziehen Sie die Schraube fest, bis Sie den Schlüssel klicken hören. Überprüfen Sie, dass der rote Pfeil nach dem Festziehen zur Radmitte weist.

FR Appliquer la clé sur la tête de la vis et serrer jusqu'à percevoir le déclic de la clé. Après le serrage s'assurer que de la flèche rouge est bien orientée vers le milieu de la roue.

ES Colocar la llave en la cabeza del tornillo y ajustarlo hasta sentir el clic de la llave. Compruebe que al final del ajuste la flecha roja esté orientada hacia el centro de la rueda.

4

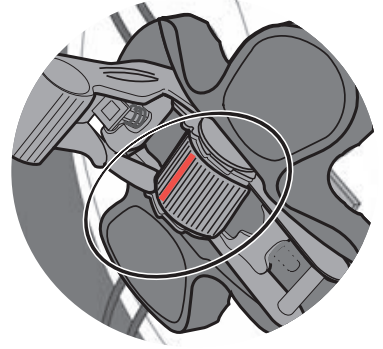
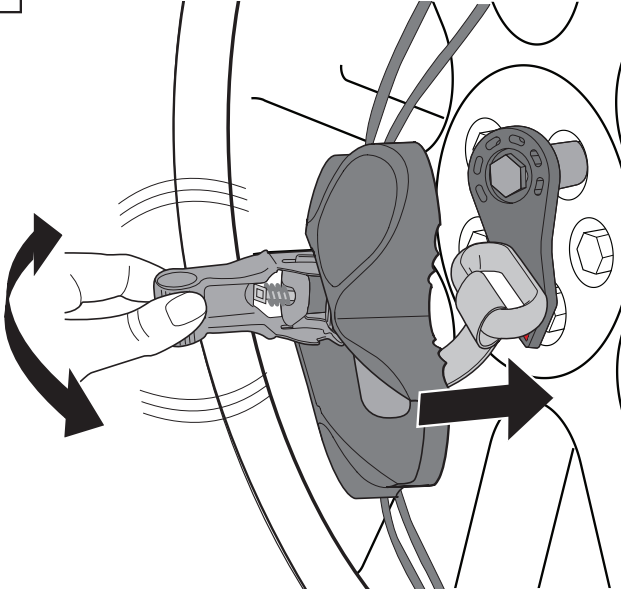

5

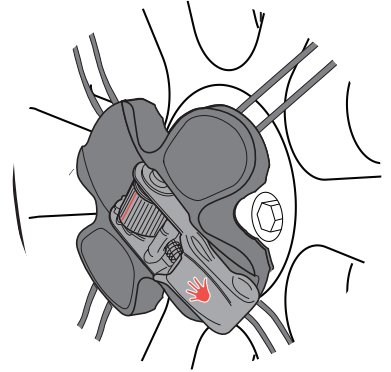
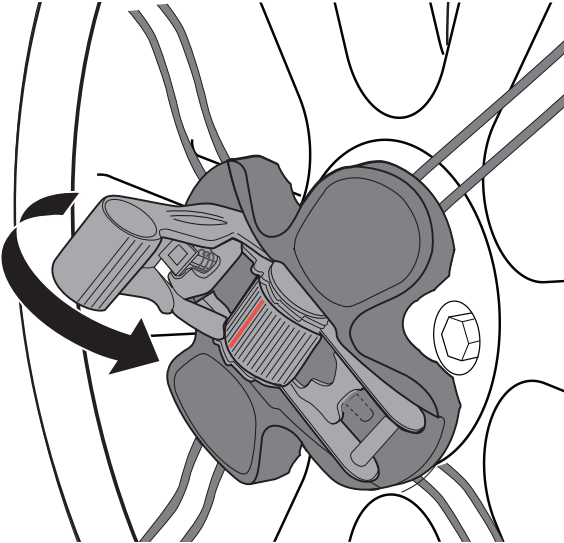

6

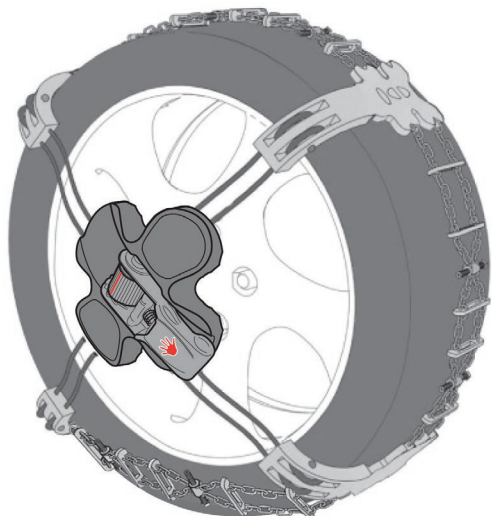

EN K-Summit will lay on the tyre during driving

IT La catena da neve si disporrà sul pneumatico autonomamente durante la marcia

DE Die Schneekette automatisch während der Fahrt um den Reifen

FR La chaîne à neige se placera toute seule sur le pneu pendant la conduite

ES La cadena de nieve se situará sobre el neumático automáticamente durante la marcha

REMOVING

1

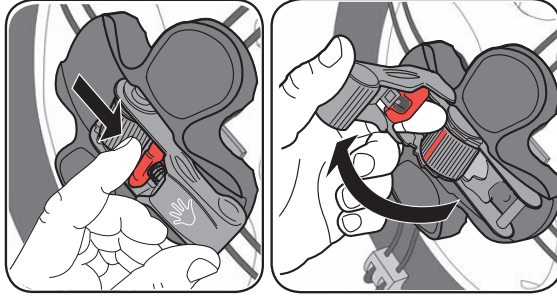

Clack!

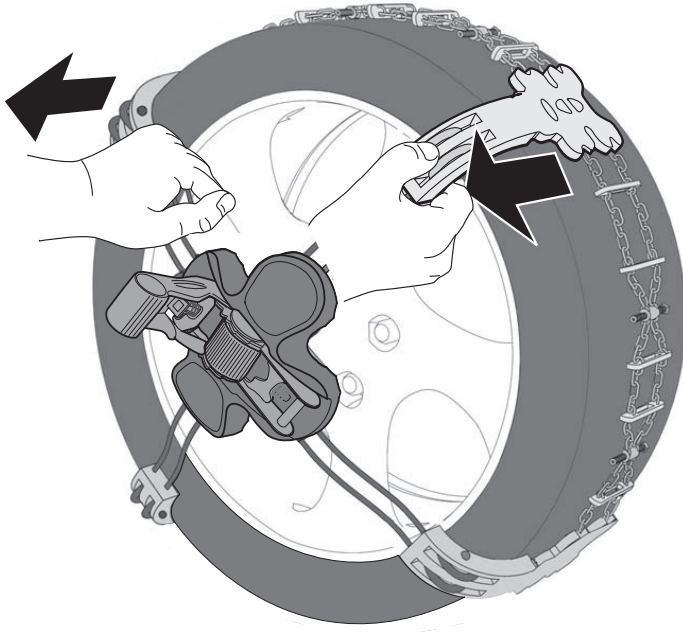
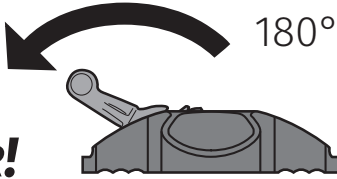

2



3

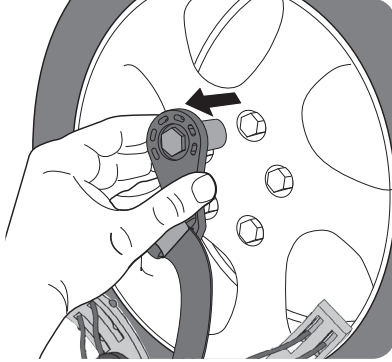

4

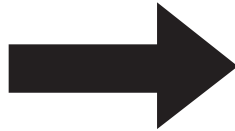
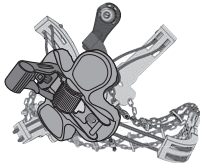

EN INSTRUCTIONS AND RECOMMENDATIONS FOR USE

Dear Customer,

We thank you for choosing our tire chains, and congratulate you on your wise choice, we have made every effort to make these chains easy and safe to use. All materials are of the highest quality, packaging and coloured parts are produced with non-toxic materials that conform to all European regulations. Please be reminded that tire chains are an emergency item which permits to use the vehicle when the roads are covered with snow or ice. You must drive carefully, avoid sudden acceleration or sudden stops, and never exceed 50 km/h. Always check what is written in the car's "Maintenance and use manual" and follow the instructions in it. Check that the car tyre measurement matches one of the measurements indicated on the case. It is a good idea to try and put the chains on and take them off at home, before leaving to go somewhere.

The chain may break if it is worn more than 45%. If unable to make a temporary repair with the repair links provided, remove the chain immediately to avoid damage to the car. To keep the chains in good condition, we recommend cleaning them carefully in hot water to remove salt deposits and prevent the formation of oxides, and drying them before replacing them in their box.

IT AVVERTENZE E CONSIGLI D'USO

Gentile cliente,

Ci complimentiamo con lei per l'ottima scelta e la ringraziamo per la preferenza accordataci. Ci permettiamo di ricordarle che abbiamo fatto tutto quanto possibile per rendere le nostre catene sicure e facili da montare. Tutti i materiali utilizzati sono di altissima qualità, le confezioni e i particolari plastificati sono realizzati con prodotti atossici e rispettano tutte le normative europee in vigore. Si ricorda comunque che le catene sono un mezzo di emergenza, che permettono di utilizzare il veicolo quando le strade sono innevate o ghiacciate. Occorre pertanto guidare con la massima prudenza, evitare accelerazioni o frenate brusche e non superare la velocità di 50 Km/h. Verificare in ogni caso quanto scritto sul "Libretto uso e manutenzione" del veicolo e attenersi alle indicazioni su di esso riportate. Controllare che la misura dei pneumatici del veicolo corrisponda a una delle misure indicate sulla valigetta. È buona norma provare a montare e smontare le catene a casa, prima di mettersi in viaggio.

Quando l'usura delle maglie della catena supera il 45% dello spessore, le catene possono rompersi; se non è possibile ripararle provvisoriamente con le false maglie in dotazione, smontarle subito per evitare danni al veicolo. Per una buona conservazione delle catene, si raccomanda, dopo l'uso, di lavarle accuratamente con acqua calda per rimuovere i depositi di sale ed evitare la formazione di ossidi, e di asciugarle prima di riporle nella confezione.

DE HINWEISE UND RATSCHLÄGE ZUM GEBRAUCH

Werter Kunde,

Wir gratulieren Ihnen zur hervorragenden Wahl und danken Ihnen daß Sie sich für unser Produkt entschieden haben. Wir erlauben uns Sie darauf hinzuweisen, daß wir alles daran gesetzt haben diese Ketten so sicher und einfach wie möglich montieren zu können. Alle verwendeten Materialien sind von höchster Qualität. Die Verpackungen und die mit Kunststoff überzogenen Teile sind aus antitoxischen Materialien und entsprechen allen gültigen Normen. Es wird daran erinnert, daß die Kette eine Hilfe für schwierige Situationen ist, die uns erlaubt das Fahrzeug auch auf verschneiten und vereisten Straßen zu verwenden. Man soll auf jeden Fall mit größter Aufmerksamkeit fahren, ruckartiges Bremsen und Beschleunigen verhindern und 50 km/h nicht überschreiten. Vor dem Antritt der Reise ist es wichtig das Auflegen und Abmontieren der Ketten mit Ruhe auszuprobieren. Überprüfen Sie in jedem Fall, welche Angaben im „Handbuch“ des Fahrzeugs gemacht werden und halten Sie sich an diese. Kontrollieren Sie, dass die Maße der Reifen mit einem auf dem Koffer der Schneekette angegebenen Maß übereinstimmen. Wir empfehlen Ihnen, die Schneeketten einmal zu montieren und zu entfernen, bevor Sie die Reise antreten.

Wenn die Abnutzung mehr als 45% beträgt, kann die Kette reißen. Falls es nicht gelingt die Ketten provisorisch mit den Ersatzgliedern zu reparieren, sollte man sie sofort abmontieren um Folgeschäden am Fahrzeug zu verhindern. Um die Kette in bestem Zustand zu erhalten und vor Oxidation zu schützen wird empfohlen, sie nach dem Gebrauch mit warmem Wasser zu waschen, um Salzurückstände zu beseitigen, und anschließend trocken zu lassen, bevor sie wieder in die Verpackung zurückgelegt wird.

FR RECOMMANDATIONS ET CONSEILS D'UTILISATION

Cher Client,

nous tenons à Vous faire tous nos compliments d'avoir choisi nos chaînes à neige et Vous remercions bien vive-ment pour la confiance que Vous nous avez accordée. Nous Vous rappelons que nous avons fait l'impossible pour rendre cette chaîne plus sûre et facile à monter. Toutes les matières employées sont de la plus haute qualité, les emballages et autres parties plastifiées sont réalisés avec des produits non toxiques et respectent toutes les réglementations européennes en vigueur. De toute façon, il faut rappeler que les chaînes à neige sont un moyen de dépannage utilisé sur routes enneigées et verglacées. Il ne faut donc ni freiner ni accélérer brutalement, en respectant la vitesse de 50 km/h. Vérifier, dans tous les cas, le contenu du « Mode d'emploi et d'entretien » du véhicule et se conformer aux instructions qui y figurent. S'assurer que la dimension des pneus du véhicule correspond à l'une des dimensions indiquées sur la valise. Il est vivement recommandé d'essayer de monter les chaînes chez soi avant de se mettre en voyage. Pour les pneumatiques larges et les véhicules dont l'espace entre la roue et les organes mécaniques est très réduit, il est fortement conseillé de vérifier la "Notice d'entretien" du véhicule. Pour une conservation optimale des chaînes, veuillez les laver soigneusement avec de l'eau chaude afin d'ôter tout dépôt de sel et les protéger contre la corrosion, puis essuyez-les avant de les remettre dans leur emballage.

ES ADVERTENCIAS Y CONSEJOS PARA EL USO

Amable Cliente,

Le felicitamos por su elección y le agradecemos su confianza. Nos permitimos recordarle que hemos hecho todo lo posible para ofrecerle una cadena segura y fácil de montar. Todos los materiales utilizados son de altísima calidad, el maletín y las piezas plastificadas han sido realizados con materiales "no tóxicos" respetando todas las normativas medioambientales Europeas en vigor. Le recordamos que la cadena es un accesorio de emergencia que permite la utilización del vehículo cuando las carreteras presentan nieve o hielo. En estas circunstancias es necesario conducir con la máxima prudencia, evitando frenadas ó aceleraciones bruscas y no superar los 50 km/h. En todo caso consultar lo que se ha indicado en el "Manual de uso y mantenimiento" del vehículo y observar las indicaciones que se encuentran en el mismo. Controlar que la medida de los neumáticos del vehículo corresponda a una de las medidas indicadas en el maletín. Es buena norma intentar montar y desmontar las cadenas en casa, antes de viajar.

Cuando el desgaste supera el 45%, la cadena se puede romper, si no se procede a repararla provisionalmente con los eslabones abiertos que acompañan a la cadena (para casos de emergencia), de no ser posible dicha reparación provisional, se recomienda desmontarla para evitar daños al vehículo. Para una buena conservación de las cadenas se recomienda, después del uso, lavarlas cuidadosamente con agua caliente para remover los depósitos de sal y evitar la formación de óxidos, y secarlas antes de re

